

ELEVATION 01

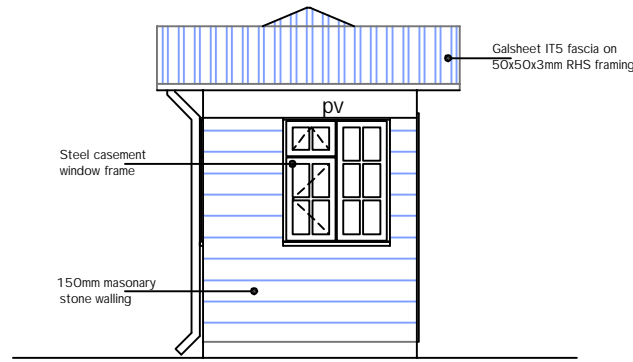

ELEVATION 02

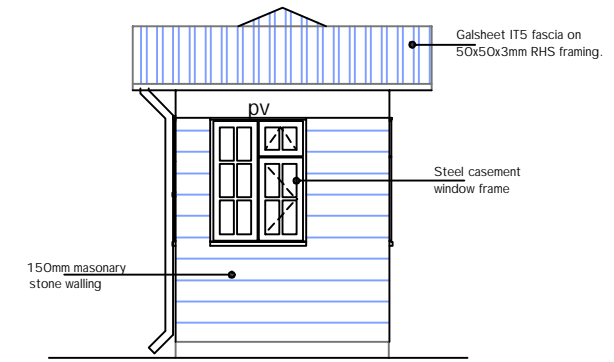

ELEVATION 03

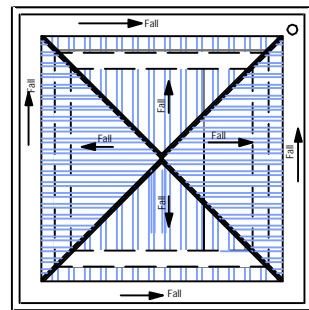

ROOF PLAN

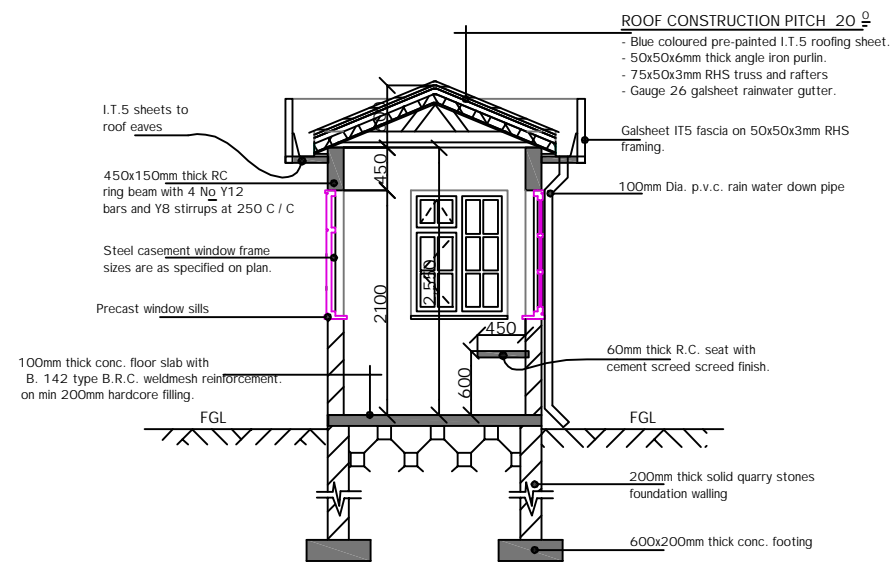

SECTION A - A

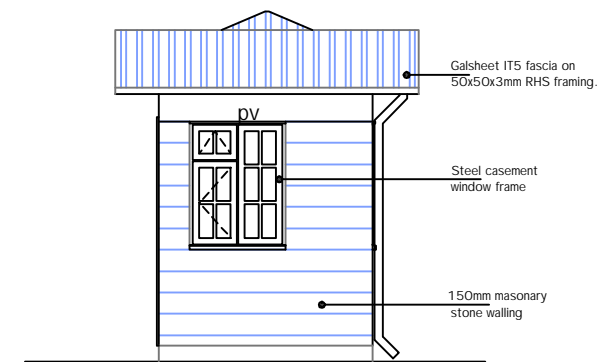

ELEVATION 04

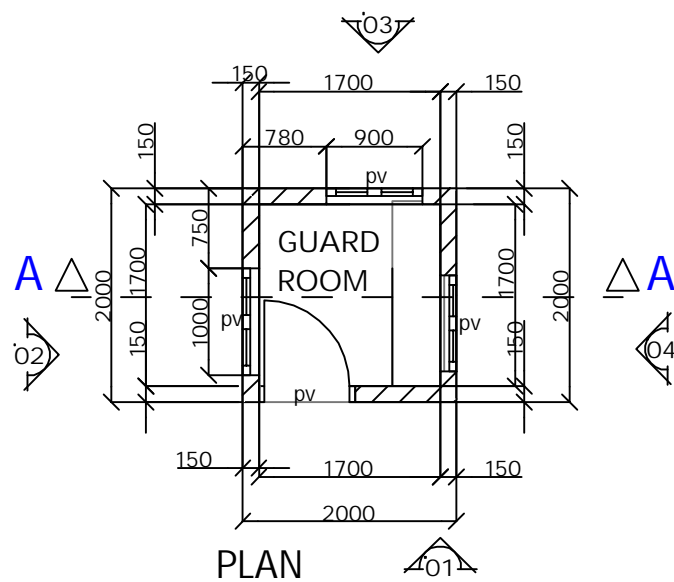

PLAN

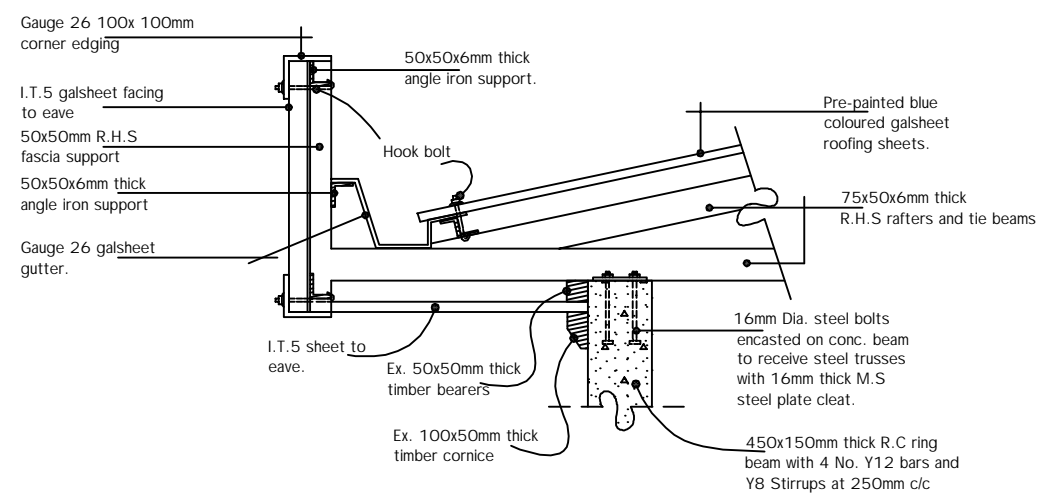

EAVE DETAIL

	NAME	DATE	SIGN	REF	REVISION	DATE	SIGN	CHECKED	DATE
APPROVED									
CHECKED ENGINEER I/C				1					
CHECKED PRINCIPAL D/MAN	B. GAITHO			2					
DRAWN	J.M.Kahare	23/02/2010		3					
TRACED				4					
				5					
				6					

DETAILS OF GUARD HOUSE AT PRIMARY SUB - STATION

SCALE 1 : 50

SHEET 3B



K.P.&.L.Co.Ltd

SK. No. 09847/A